

BRIDGE TO UNITY

Bringing communities together

**Cultural Activity Pack for Schools
#1: Afghanistan**

Afghanistan is a land-locked country in the centre of Asia. It borders 6 countries: Pakistan, Iran, Turkmenistan, Uzbekistan, Tajikistan and China.

Afghanistan has a population of 40.2 million and it covers over 251,000 square miles of land, making it a little bit bigger than France.

Afghanistan's capital city is called Kabul and is found in the East. It's main languages are Pashto and Dari. Over 99% of the country are Muslim. It's currency is called the Afghani.

Afghanistan has lots of mountain ranges and flat land called plateaus. The country's highest point is Nushaq, which is 7492 metres above sea level - that's the same as 23 Eiffel Towers stacked on top of each other. Although Afghanistan is a very dry country with incredibly hot summers, in the winter it receives lots of snow in its mountains.

Afghanistan's flag is black, red and green and at its centre is the national emblem which includes a picture of a mosque, two flags and an Arabic inscription.

Afghanistan's national animal is the snow leopard, the golden eagle is its national bird and the tulip is its national flower.

AFGHANISTAN QUIZ

TRUE OR FALSE

TICK THE CORRECT ANSWER BOXES. USE YOUR FACT SHEET TO HELP YOU.

		TRUE	FALSE
1	Afghanistan is SMALLER than the United Kingdom		
2	Afghanistan's capital city is called JALALABAD		
3	Afghanistan has a population of LESS than the United Kingdom		
4	Afghanistan is dry ALL YEAR		
5	Afghanistan is bordered by the RED SEA		
6	Afghanistan's population is largely MUSLIM		
7	The main languages in Afghanistan are PASHTO & DARI		
8	The flag of Afghanistan is RED & BLUE		
9	Afghanistan's national animal is the TIGER		

AFGHANISTAN QUIZ

WRITE YOUR ANSWERS IN THE BOXES. USE YOUR FACT SHEET TO HELP YOU.

1	How many metres above sea level is Afghanistan's highest mountain?	
2	How many countries border Afghanistan?	
3	What COLOURS are used on Afghanistan's flag?	
4	What EMBLEM is on the flag of Afghanistan?	
5	What is the name of the HIGHEST MOUNTAIN in Afghanistan?	
6	What is the CAPITAL of Afghanistan?	
7	What are the MOST COMMON languages in Afghanistan?	
8	What is the CURRENCY in Afghanistan?	
9	Draw Afghanistan's NATIONAL FLOWER:	10 Can you think of any more facts about Afghanistan?



----- Cut along the dotted lines to create a flag.
Make sure you ask an adult first!



**COLOUR
ME IN!**

You will need:

BLACK

تور

RED

سور

GREEN

شین

سیاه

سرخ

سبز

Flag of Afghanistan

بیرق افغانستان | د افغانستان بیرغ

LANGUAGES OF AFGHANISTAN

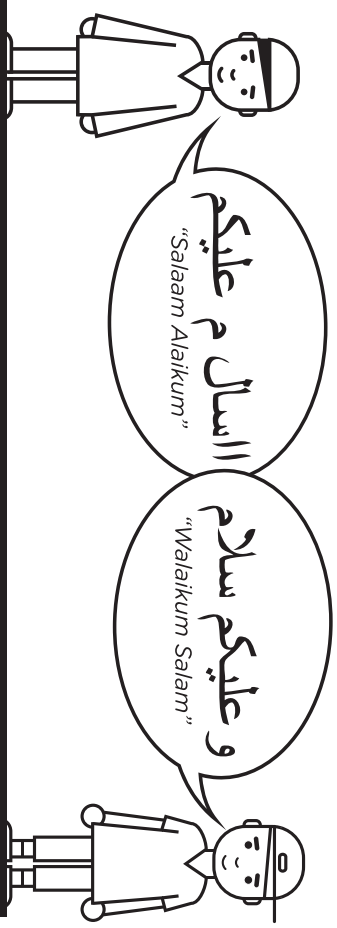

داری

Dari is a version of the Persian language, spoken by the majority of people in Afghanistan.

English	Dari	How to say it (phonetics)
How are you?	چطور هستید؟	"Ci hâl dêrî?"
Thank you	تشکر از شما	"Tašakor"
Goodbye	خداحافظ	"Xudâ hâfez"
My name is...	اسم من ... هست	"Esme-man [name] ast"
Yes	بلی	"Bale"
No	نخیر	"Ne"
Please	لطفاً	"Lotfân"
Good Morning	صبح بخیر!	"Sobh baxir"

پښتو

Pashto is the main language of the Pashtun people and is also spoken in northern areas of Pakistan.

English	Pashto	How to say it (phonetics)
How are you?	تاسې څنگه یاست؟	"Teh Singa jee?"
Thank you	ستاسو څخه مننه	"Manana"
Goodbye	د خدای په امان	"da Khoday pa amaan"
My name is...	زما نوم دی	"Zama noom [name] dai"
Yes	هو	"Ao"
No	نه	"Nah"
Please	مهرباني	"Merabaanî"
Good Morning	سهار په خیر	"Sahr Pikhayr"

Where on Earth is Afghanistan?



Use a map to locate the **six countries** that surround Afghanistan.

Write your answers in the empty bubbles.

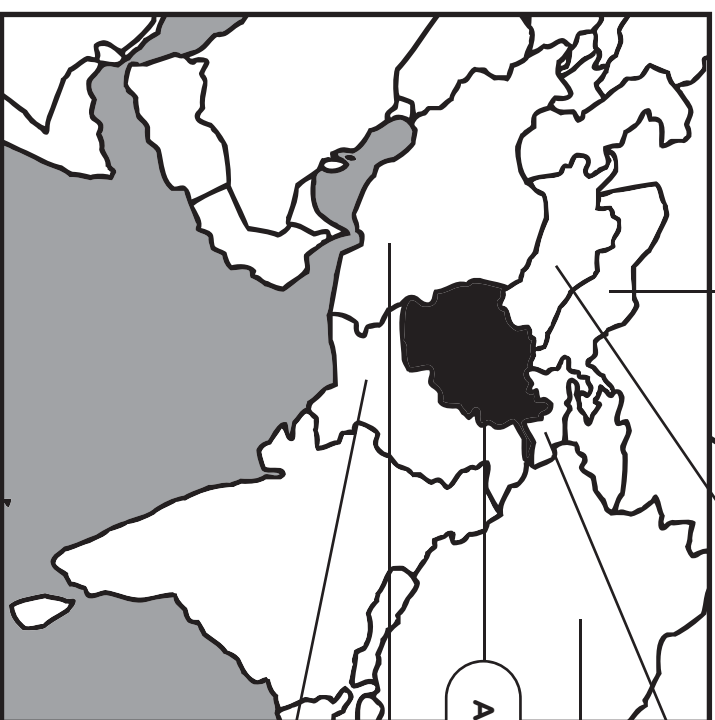
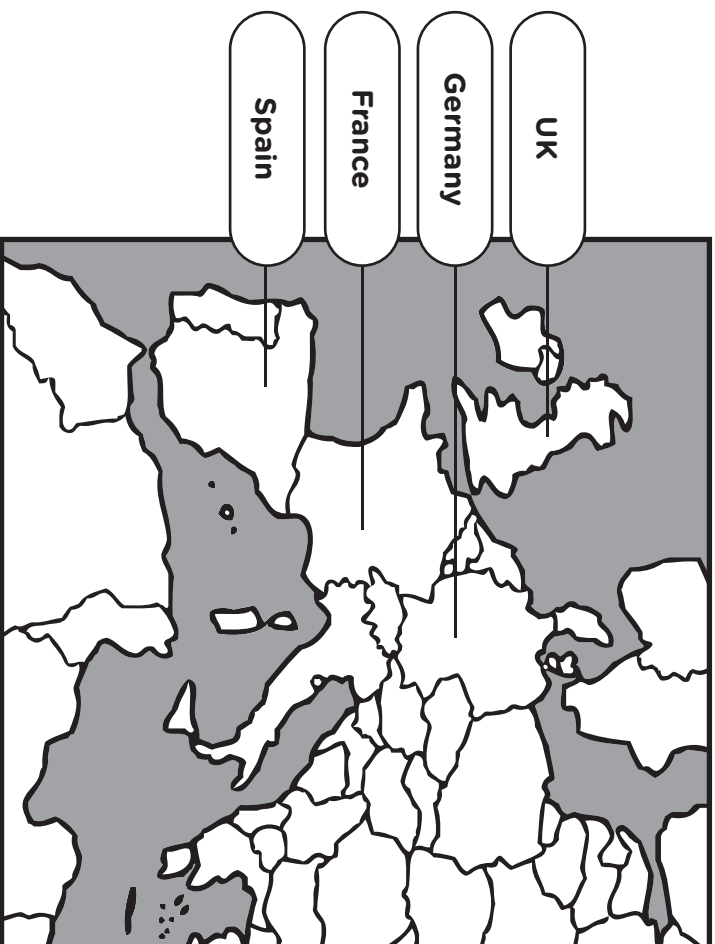
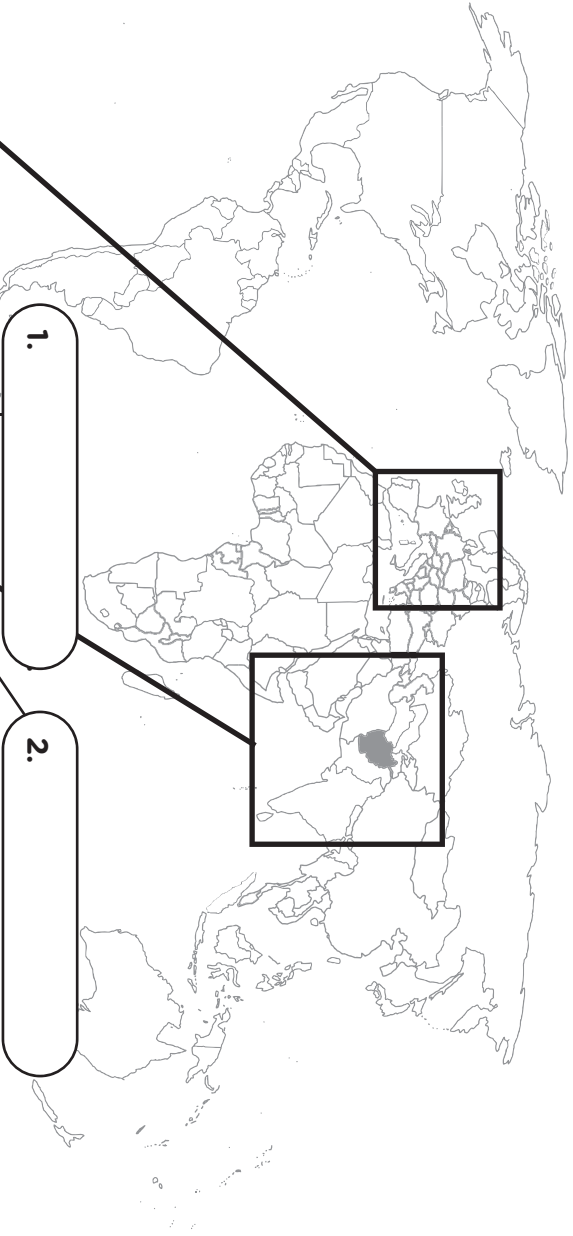

- 1.
- 2.
- 3.
- 4.
- Afghanistan
- 5.
- 6.

9+



Afghanistan is surrounded by six other countries - let's mark them on the map!

1. Create a **KEY** by choosing a different colour for each country.
2. Colour in the correct countries on the **MAP** using the colours from your **KEY**.

KEY

Afghanistan	
Iran	
China	
Pakistan	
Tajikistan	
Uzbekistan	
Turkmenistan	

MAP





1. Draw a line between London in the UK, and Kabul in Afghanistan.

Afghanistan



2. How many people do you think live in Kabul?

3. How many miles do you think it is from London to Kabul?

4. How many people do you think live in London?

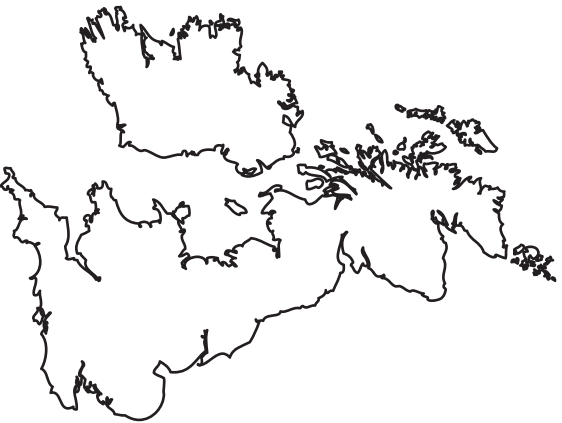

United Kingdom (UK)

A TASTE OF AFGHANISTAN

PLATE

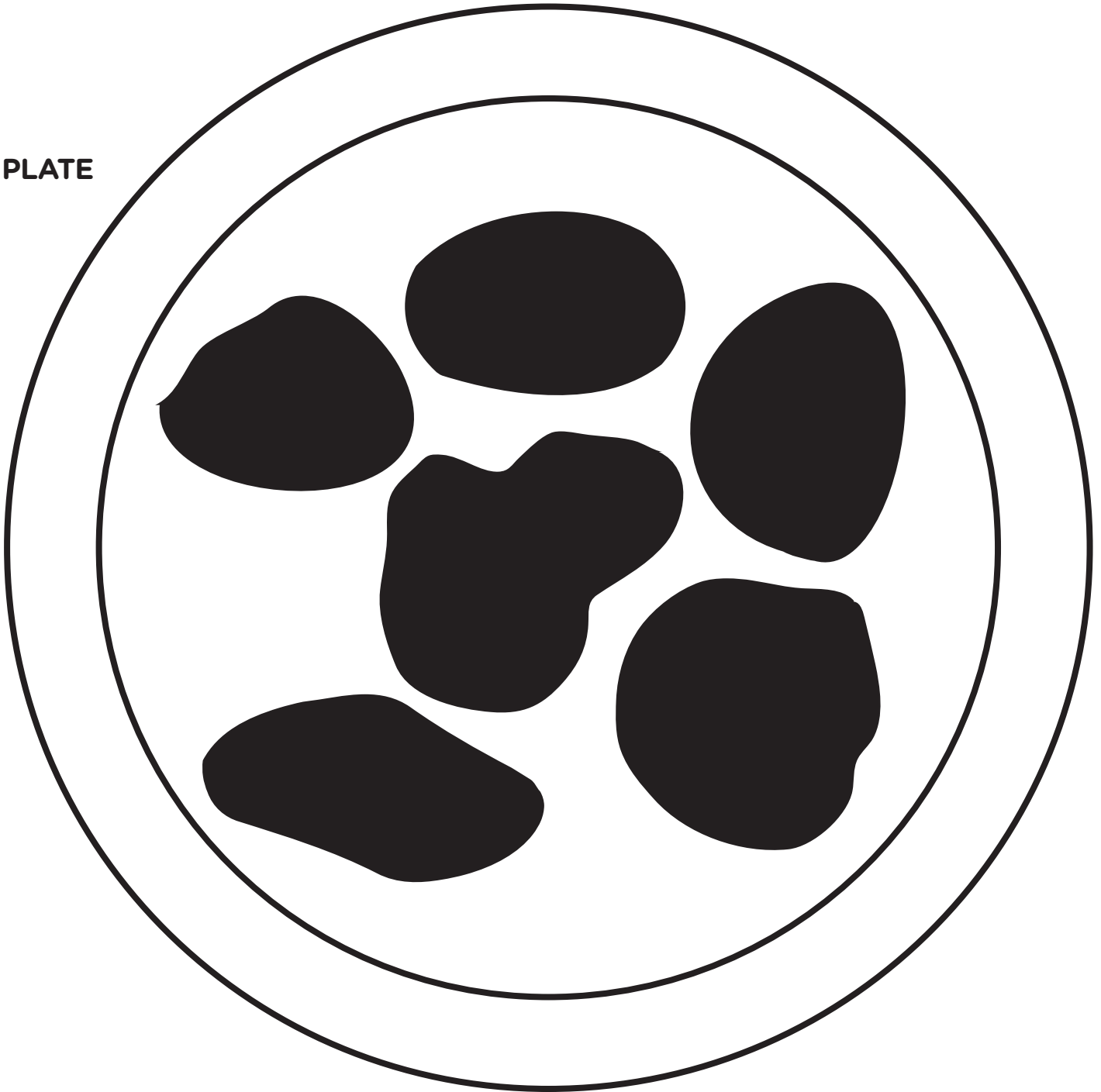

DISHES



Mantu

Savoury beef and onion stuffed dumplings.



Kabuli Pulao

A rice dish made with meat, raisins and carrots.



Chapli Kabab

Beef or lamb patties served with salad and naan.



Bolani

Flatbreads stuffed with potatoes, meat and other vegetables.



Chainaki

Lamb stew cooked and often served in a teapot.



Dough

A yoghurt drink flavoured with mint and cucumber.

DISHES

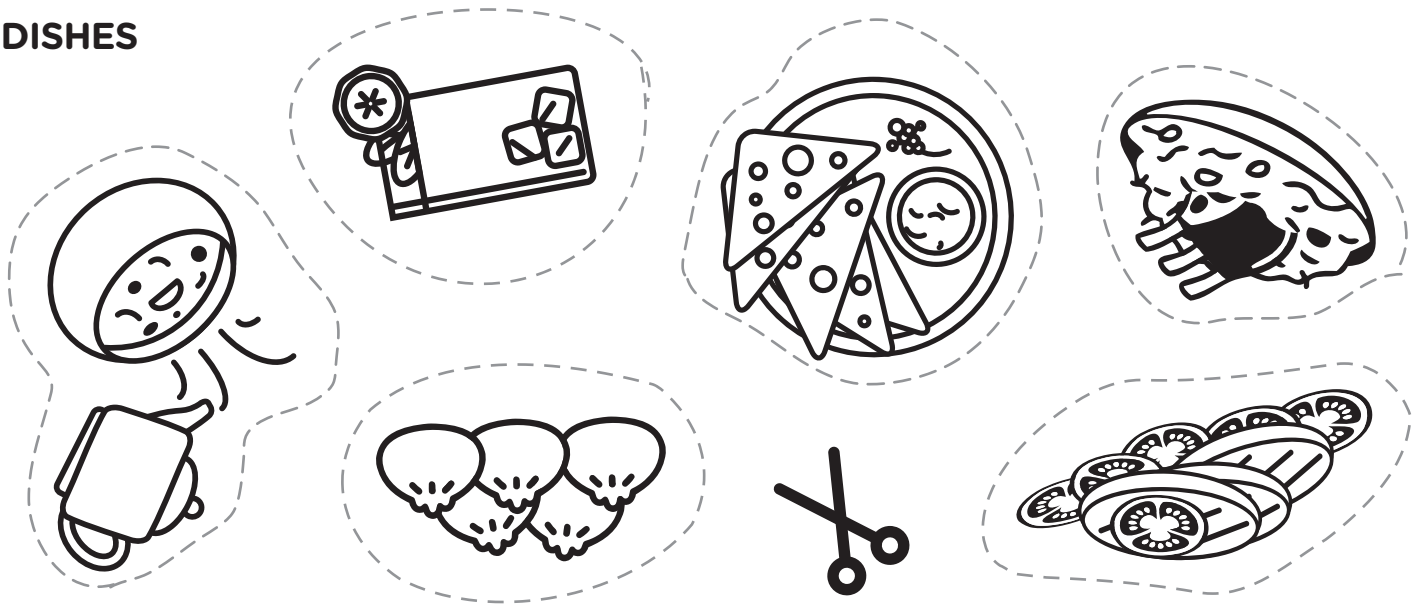

INSTRUCTIONS

1. **Carefully** cut out the different **DISHES** on this sheet - **ask an adult to help you.**
2. Put each dish in the right place on your **PLATE.** **Tip: use the shapes to help you!**
3. Use the key at the bottom to learn about each dish.
4. Answer the questions below...

QUESTIONS

Which dish contains fruit?

What object can Chainaki be served in?

For which dish might you require a straw?

Which dish would you most like to try and why?

FACT SHEET

MONEY IN AFGHANISTAN

United Kingdom



Pound Sterling (£)
GBP



The currency of the UK is called the Pound Sterling.

A one pound coin has a silver looking centre with a gold border.

Afghanistan



Afghani (ؑ)
AFN



The currency of Afghanistan is called the Afghani.

A one Afghani coin is circular and is made of copper plated steel – the same as 1p and 2p coins here in the UK.

Afghani Coins

On 11 April 2005, Afghani coins were introduced in denominations of 1, 2 and 5 Afghanis.

1 AFN



2 AFN



5 AFN



Value

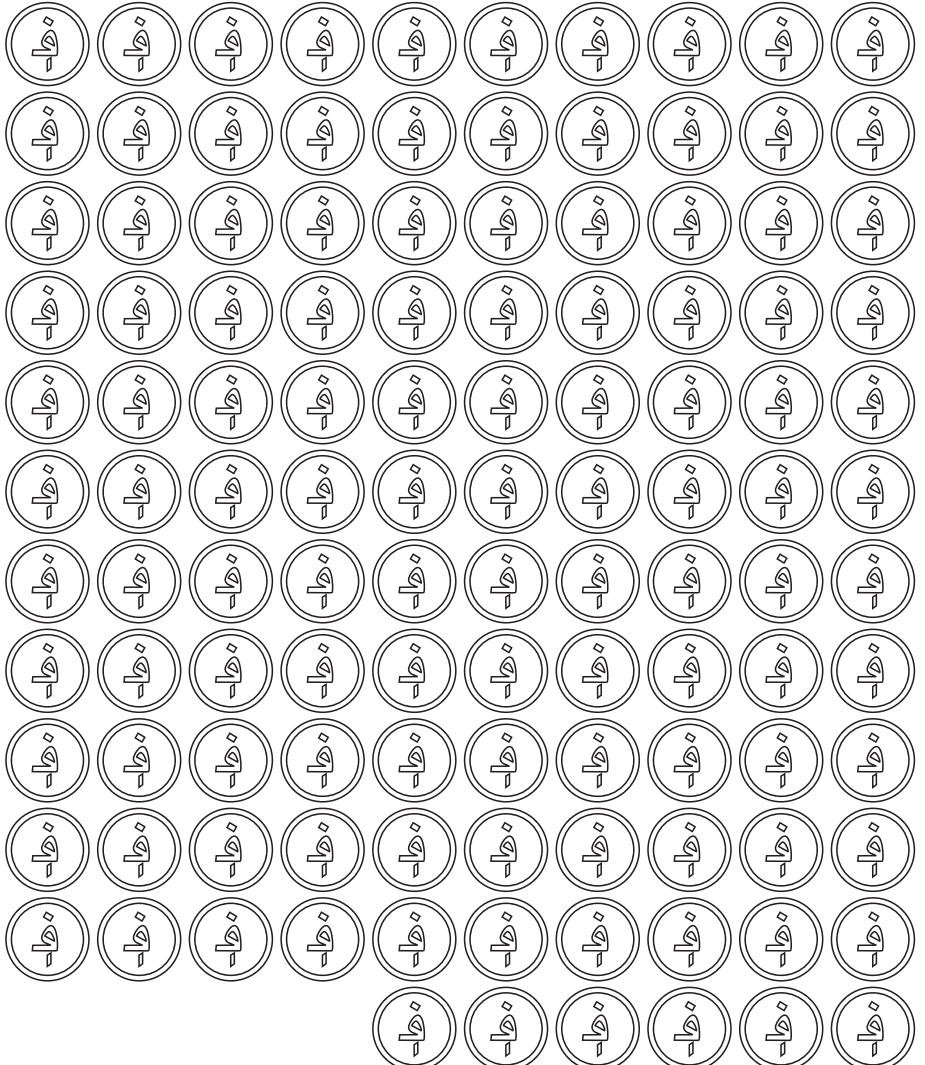

In March 2022,
£1 (GBP) was worth
the same as
ؑ116 (AFN).

In the UK, **£1 = 100 pennies**.

In Afghanistan, **ؑ1 = 100 pulis**.

However, pul coins are no longer in circulation and the **ؑ1** coin is now the smallest value coin you can use.

MONEY IN AFGHANISTAN

USE YOUR FACT SHEET AND A CALCULATOR TO HELP YOU.
WRITE YOUR ANSWERS IN THE BOXES.



<p>1 How much would the bag of rice cost in Afghani (AFN)?</p>	
<p>2 How much would the basket of vegetables cost in Pounds (GBP)?</p>	
<p>3 How many AFN would you need to buy the cheese and potatoes?</p>	
<p>4 How many 5 AFN coins would you need to buy the sausages?</p>	
<p>5 How many puls would you need to buy the fizzy drink?</p>	
<p>6 How many 2 AFN coins would you need to buy the loaf of bread?</p>	
<p>7 How many AFN would you need to buy all of the items?</p>	

**SPOT
THE
DIFFERENCE**

Can you spot the 9 differences between these pictures?

Circle the answers.

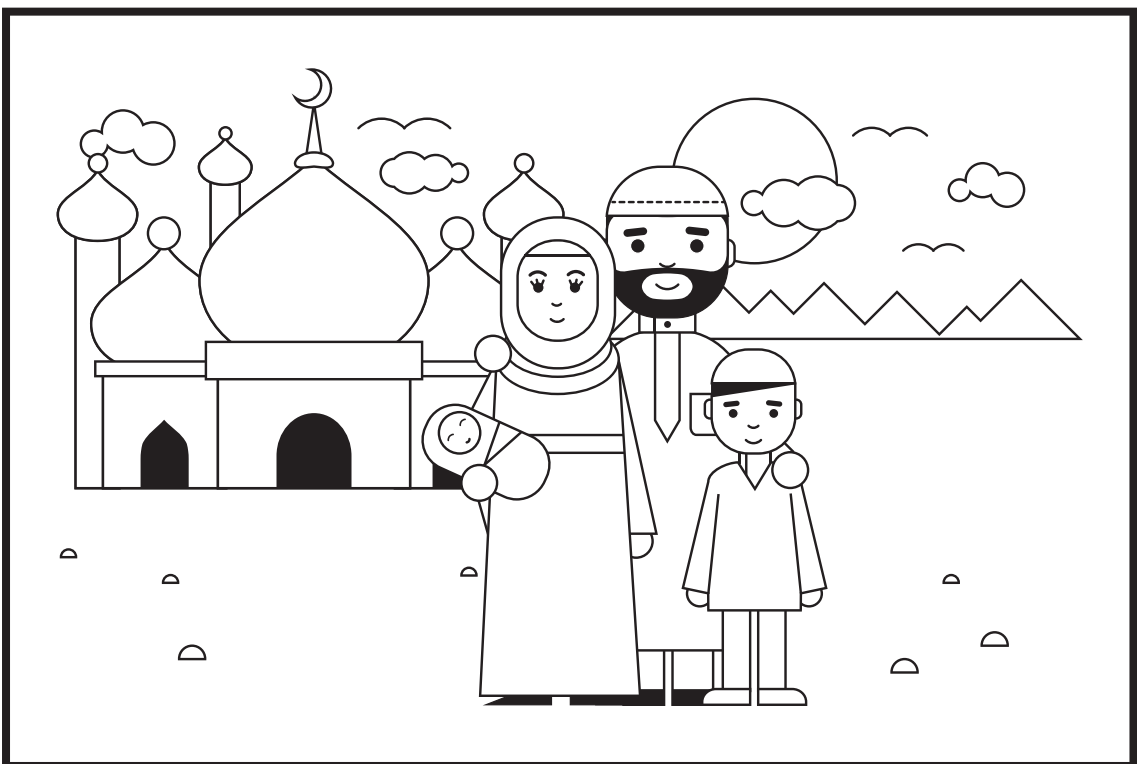

MAZE

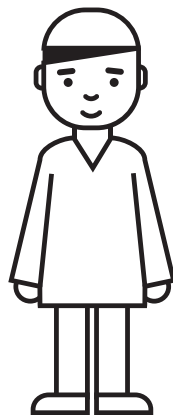

Help Sayed find the Mantu!

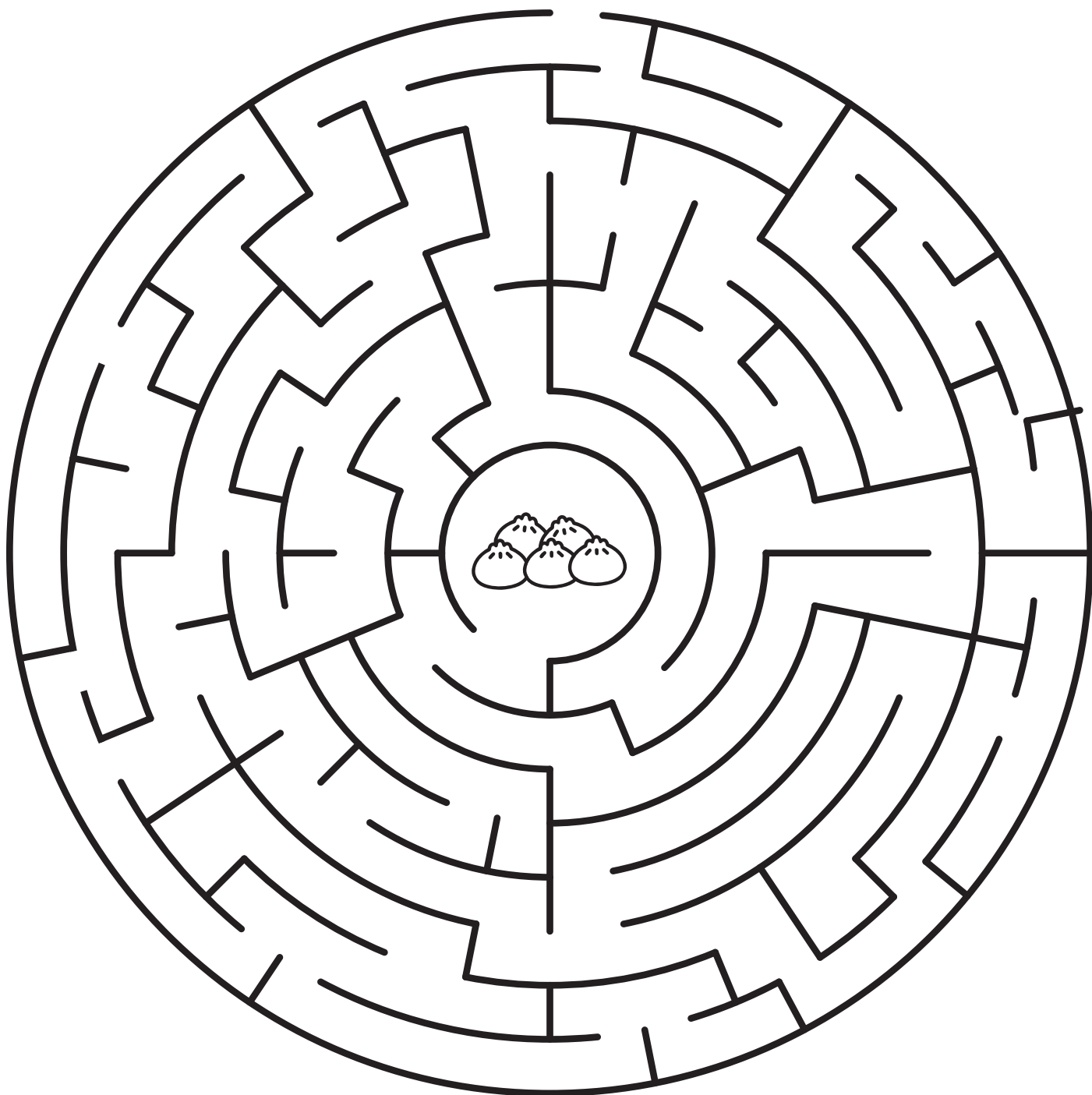

PRACTICE SHEET



Have a go at writing **AFGHANISTAN** in **Dari**.
Use the guidelines to help you.

Once you have completed your three practices you can write your final version using the template. You can use any colour you want to!

افغانستان

Tip: Try using a paint brush with paint or ink. If you find this too difficult you can use a pen or just colour the letters in.

افغانستان
افغانستان
افغانستان

I CAN WRITE...

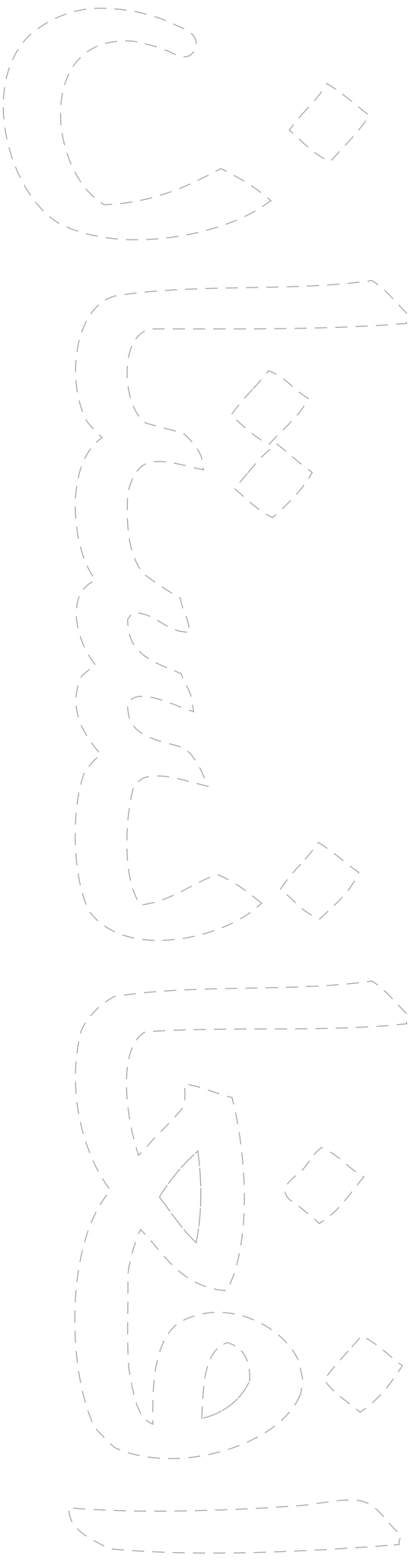

AFGHANISTAN

NAME:

AGE:

DOT TO DOT

Join the dots to draw the bird.
Start at number 1!

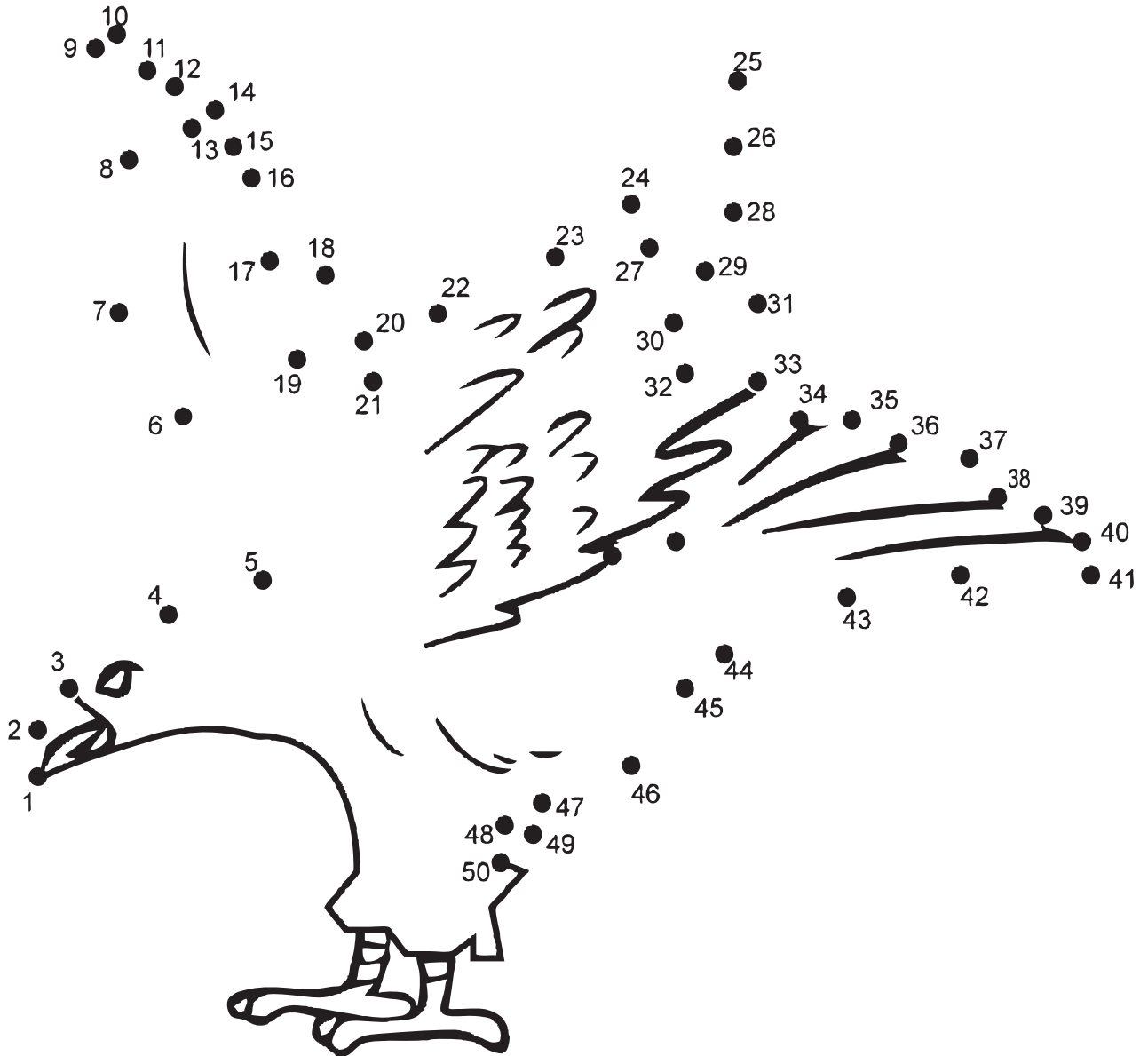

The Golden Eagle

عقاب طلايي | طلايي عقاب

is the national bird of Afghanistan.

DOT TO DOT

Join the dots to draw the animal.
Start at number 1!

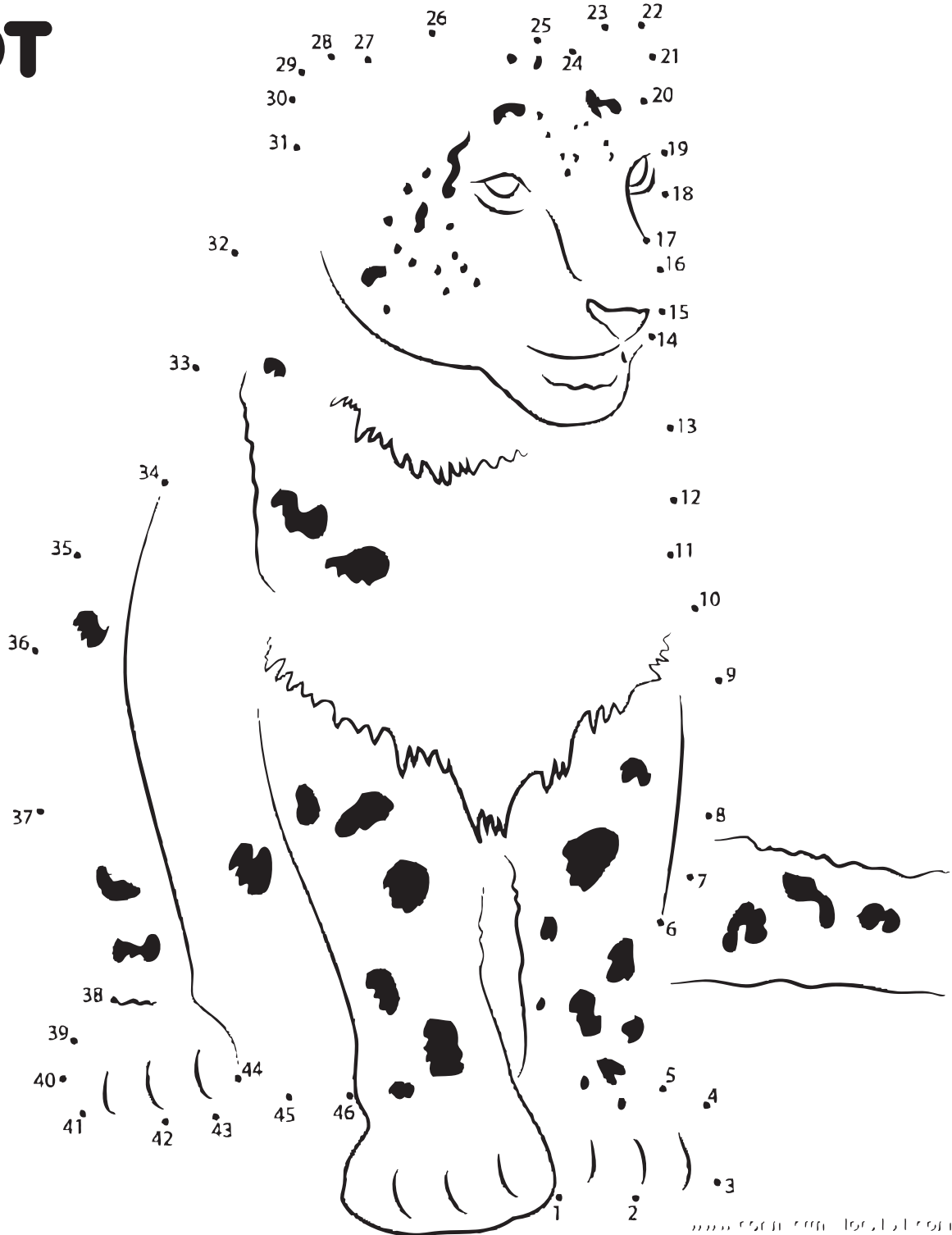

The Snow Leopard

پلنگ برفی | د واوړې پړانگ

is the national animal of Afghanistan.

DOT TO DOT

Join the dots to draw the flower.
Start at number 1!

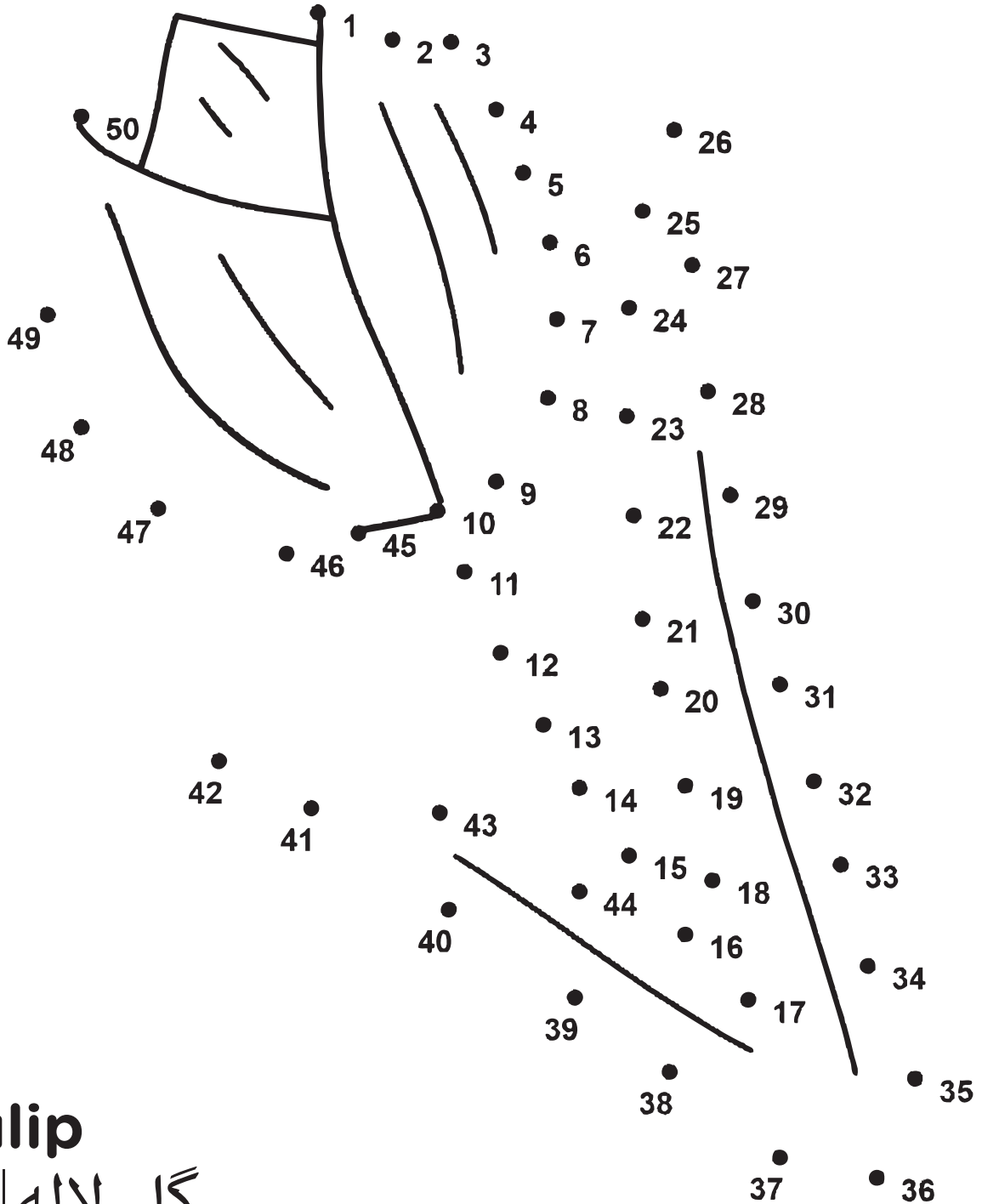

The Tulip

گل لاله | غایتول

is the national flower of Afghanistan.

WORDSEARCH

L Y T Z U P J N O W K H D K D
Y A U J A S F X T G A H O R W
P Q N S H E O W V H B K A I P
P I H D U F S T R M U S L I M
H T L Q L Q L Y D E L B J R I
O Z S U O O H P B G X G K K X
W O Z Y T S C O E Y Y E R P Q
M K F O L E Q K G D L O P A H
E U X D I Q J M E D K S O W I
H Z F D A B F G T D Q Y D W N
I Y G P M Y M D I C I E K W A
Q G R S H Z Y H A F C B G W H
I R A D B A L V A C V P I Z G
Y Q K U W Q L Y L A M A H N F
E F O S C F G N M R Q V X N A

FIND THESE WORDS!

Afghani **Dari** **Kabul** **Landlocked**

Mosque **Muslim** **Pashto** **Tulip**

Words can go in any direction.

Words can share letters as they cross over each other.

3D KITE DESIGN

Kite-flying is one of Afghanistan's national sports.

Follow the instructions to make your own 3D kite design.

Step 1

Fold a square piece of paper in half diagonally, then unfold it to create a crease.

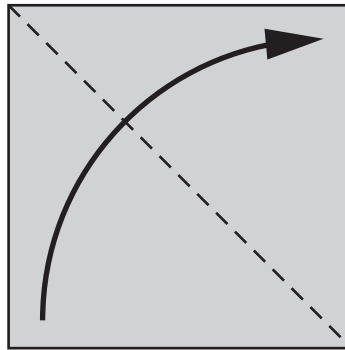

Step 2

Fold the bottom-left corner to meet the crease.

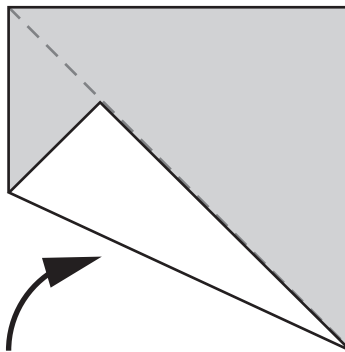

Step 3

Repeat Step 2 on the top-right corner.

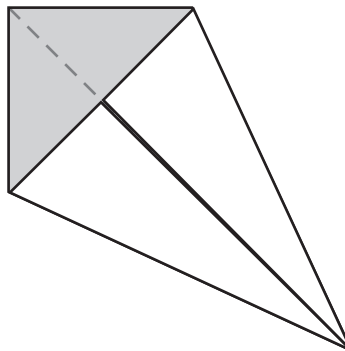

Step 4

Turn the whole sheet of paper over to see your kite sail.

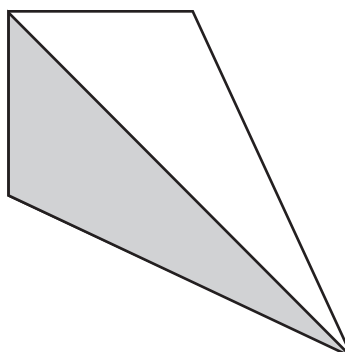

Step 5

Apply some glue to the back of your kite sail.

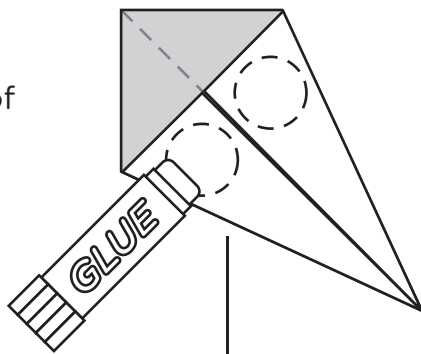

Step 6

Stick the back of your kite onto a new sheet of paper.

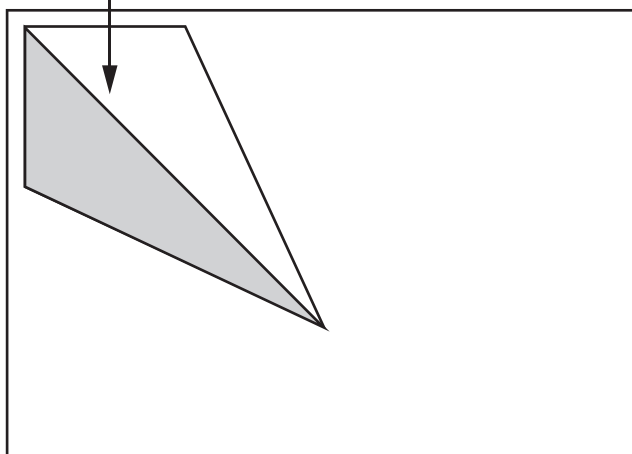

Step 7

Use a pen to draw the kite string.

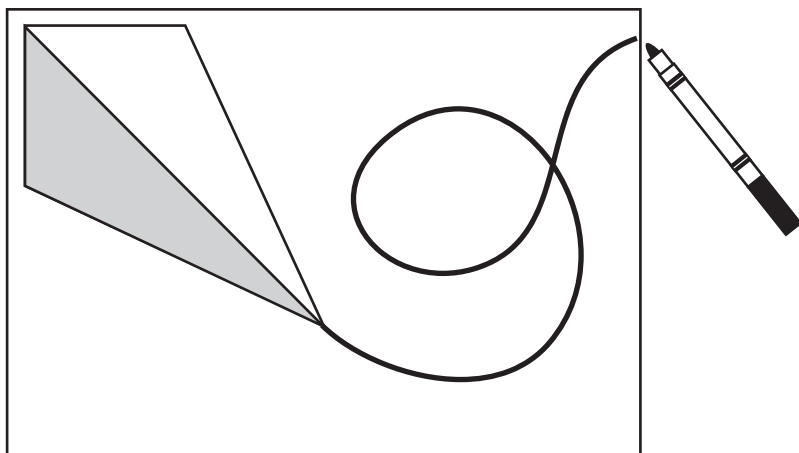

Step 8

Carefully cut out the clouds from the **Cloud Template** - ask an adult to help you.

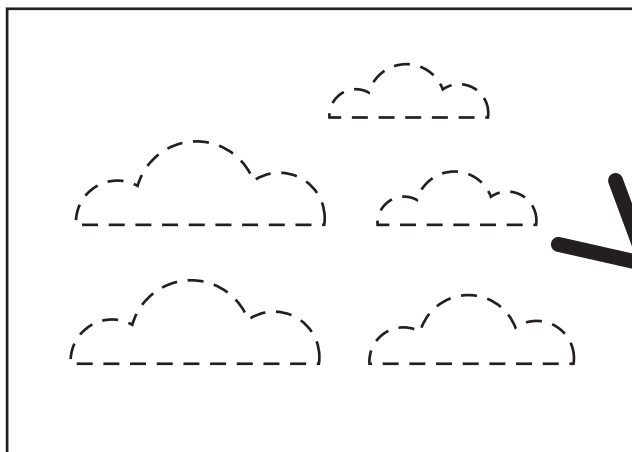

Step 8

Carefully cut out strips of paper using the template - ask an adult to help you.

Tip: Try colouring in the strips or using different coloured paper.

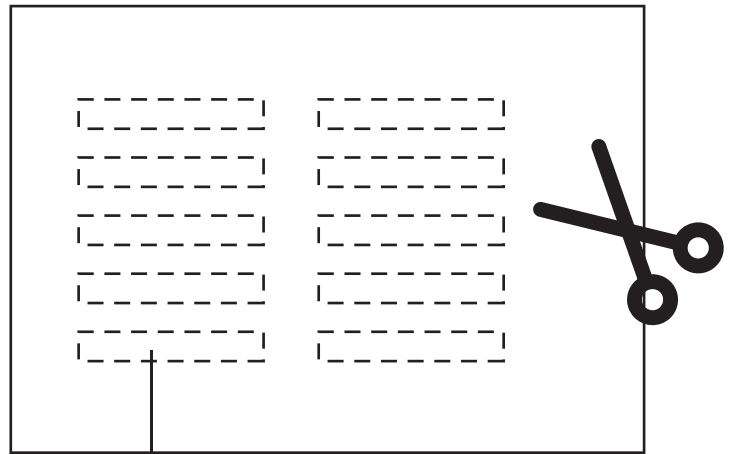

Step 8

Fold your strips in half to create the ribbons for your kite string.

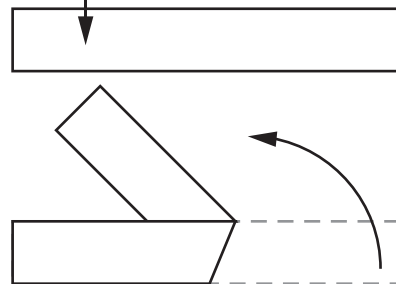

Step 10

Stick the clouds and ribbons onto your design.

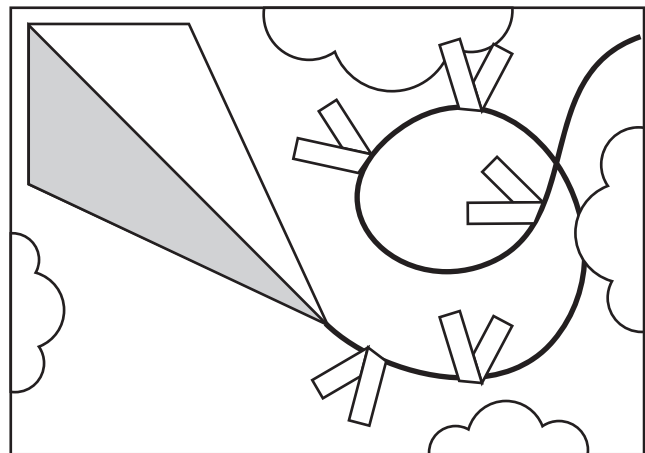
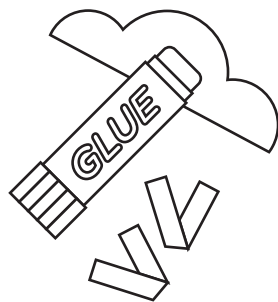

Step 11

Go crazy! Decorate your design however you want to.

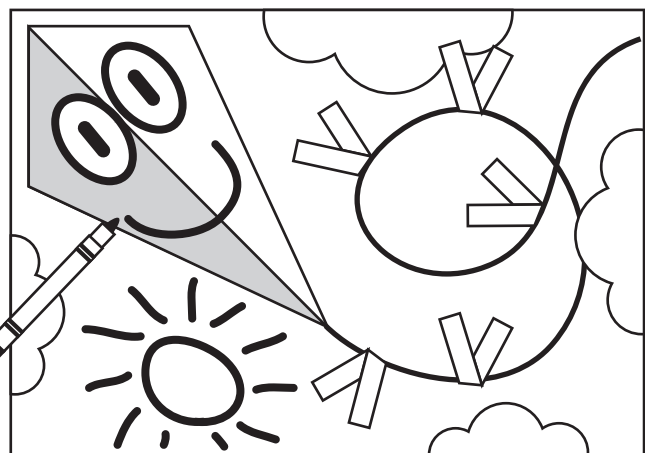
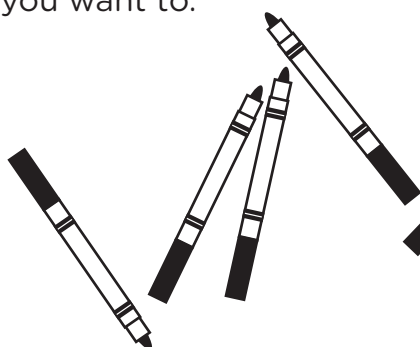

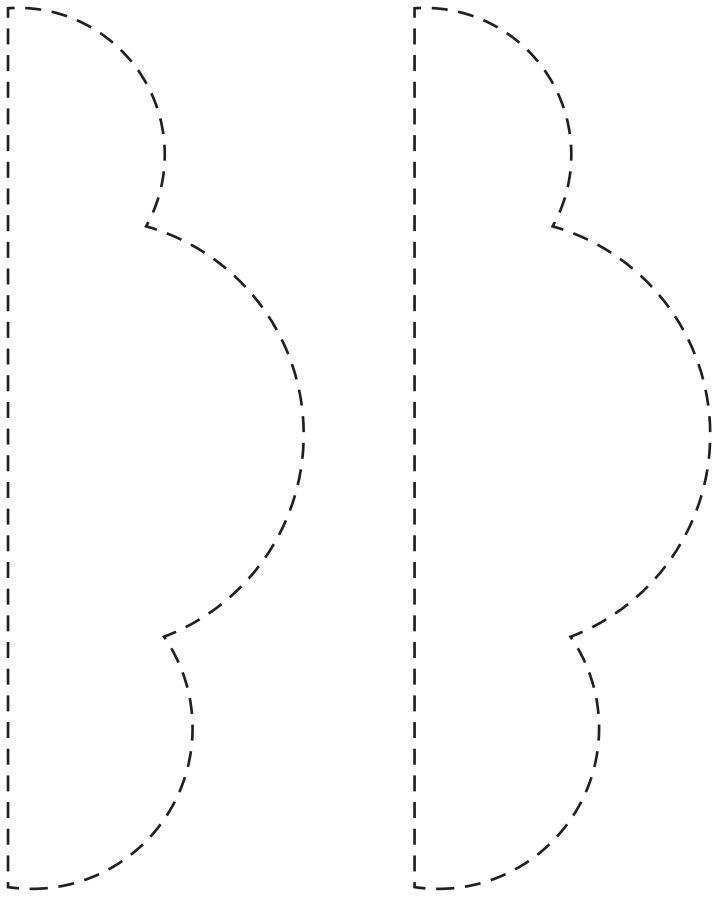

Cloud Template

Carefully cut out the clouds from the template - ask an adult to help you.

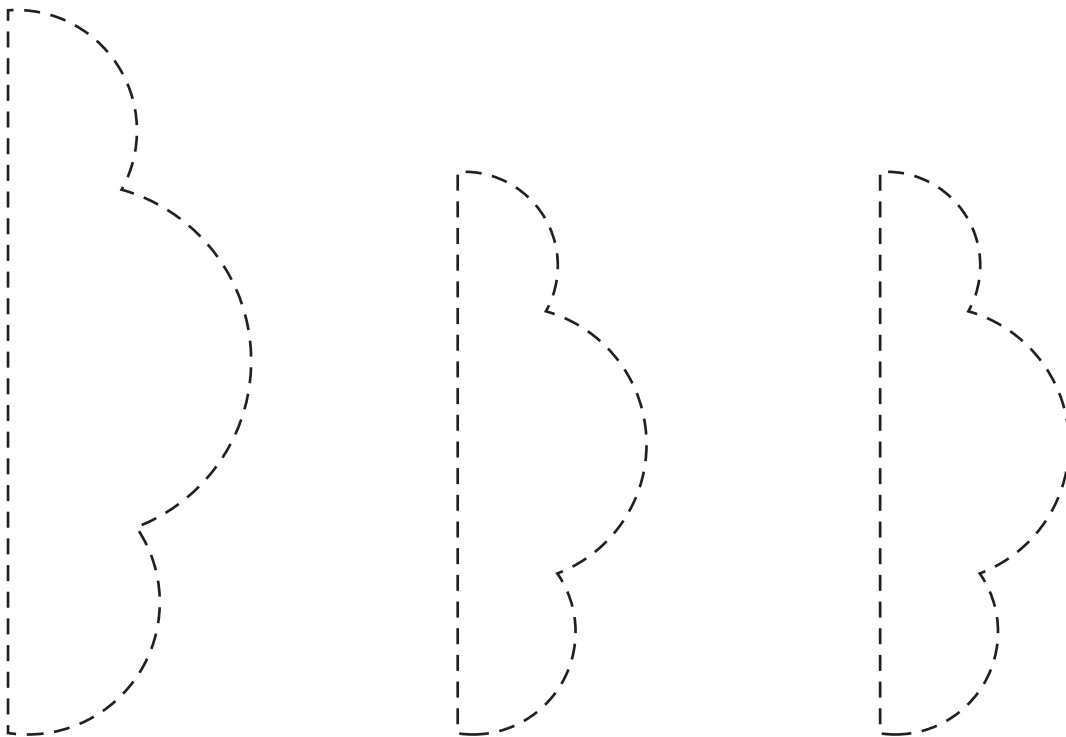

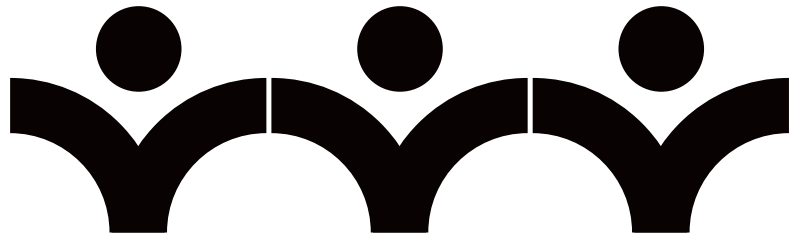

BRIDGE TO UNITY

Bringing communities together

TEACHER'S RESOURCE

**Cultural Activity Pack for Schools
#1: Afghanistan**

Dear Teachers,

From all of the Bridge to Unity team, welcome to our Afghanistan Cultural Activity Pack. Since meeting and working with those evacuated from Kabul in 2021, we have been passionate about welcoming the individuals and families that had to leave their homes in Afghanistan when fleeing for safety.

One thing that stands out to us all when working at bridging hotels is the number of children who had to leave behind their homes, their friends and their schools, to move thousands of miles to the other side of the world. It was this that gave us the idea of producing an activity pack that could be used in schools to both educate children about Afghanistan but also to give Afghan children an opportunity to showcase to their peers the country they have left and a day to feel proud about where they have come from.

The activity pack is made up of 17 different activities, all of which have been designed by the Bridge to Unity team, with direct input from individuals from Afghanistan, as well as teaching professionals.

It was important to us that we received input from both those from Afghanistan and from teachers themselves, to ensure we produced a pack that was culturally appropriate and educational.

All the activities are aimed at primary school children aged between 4 and 11. You will notice some activities are better suited to older children and some to younger. We have provided this pack as an e-document to allow you, the teacher, to decide which activities are most suitable for your class.

We hope you will enjoy this pack and if you have any questions, please do not hesitate to contact us: info@bridgetounity.co.uk

Answers 1/2

Afghanistan Fact Sheet

True or False

1. False
2. False
3. True
4. False
5. False
6. True
7. True
8. False
9. False

Written Format

1. 7,492m
2. Six
3. Black, red and green
4. A mosque
5. Noshaq
6. Kabul
7. Pashto and Dari
8. Afghani
9. Picture of a tulip
10. For older children, you could suggest they use the internet or other class resources to find additional facts and share with one another.

Where on Earth is Afghanistan?

Parts 1 & 2

1. Uzbekistan
2. Turkmenistan
3. Tajikistan
4. China
5. Iran
6. Pakistan

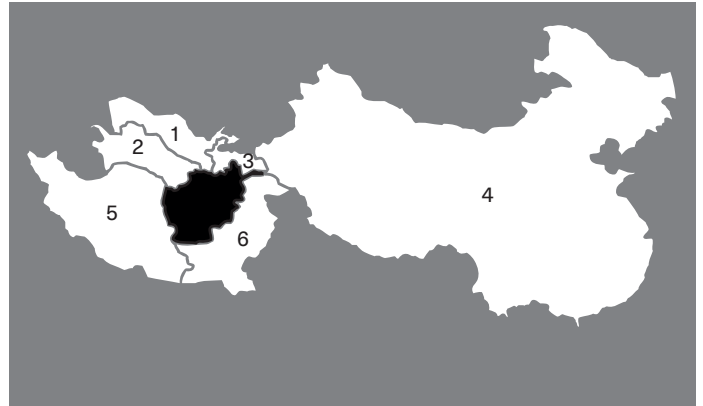

Part 3

1. Draw a line... (see stars)
2. 4.4 million
3. 4,292 miles
4. 8.9 million

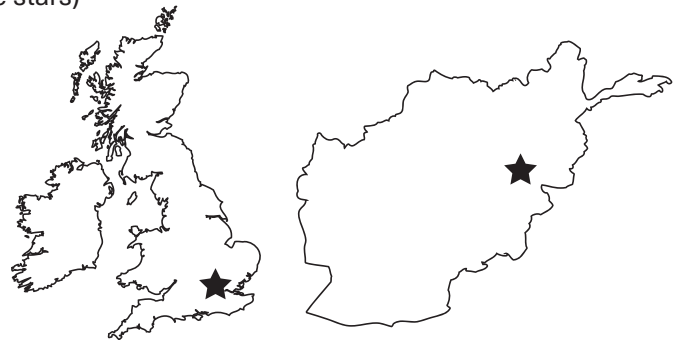

A Taste of Afghanistan

Q: Which dish contains fruit?

A: Kabuli Pulao

Q: What object can Chainaki be served in?

A: A teapot

Q: For which dish might you require a straw?

A: Dough

Money in Afghanistan

1. 174
2. £1.50
3. 259
4. 123
5. 2,800
6. 58
7. 1366

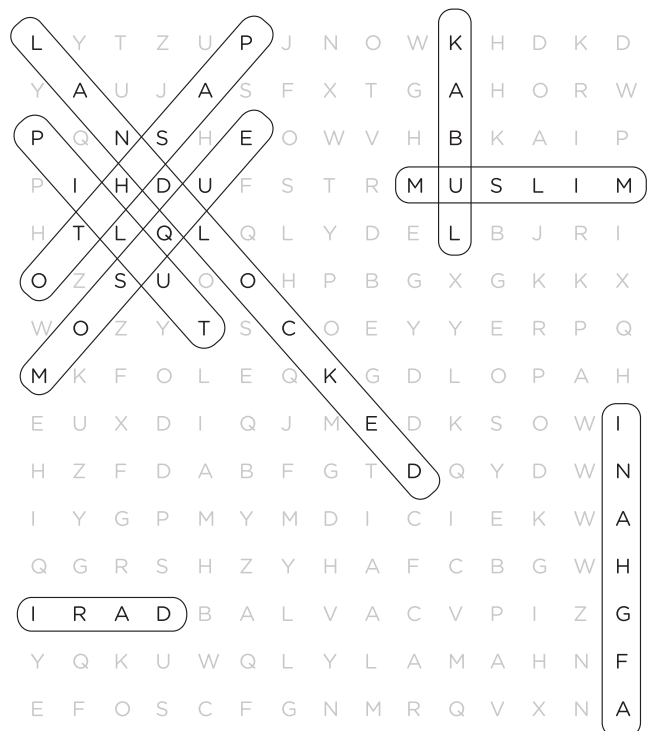

Answers 2/2

